

UNDERSHELF ASSEMBLY DETAILS BENCH NOT INCLUDED

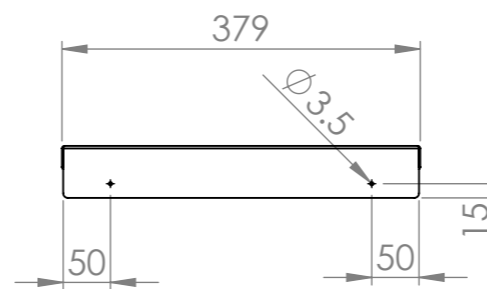

TOP HAT CHANNEL

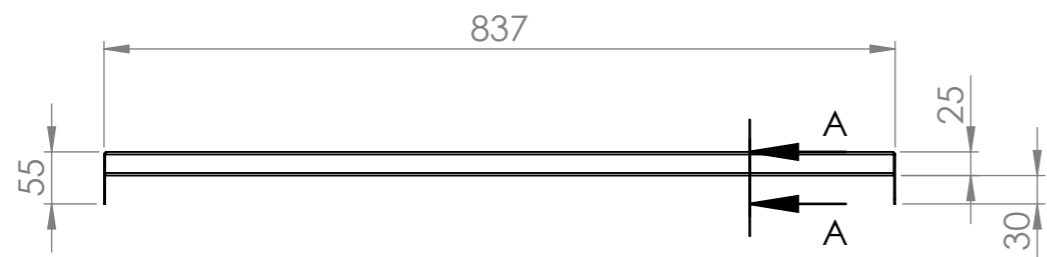
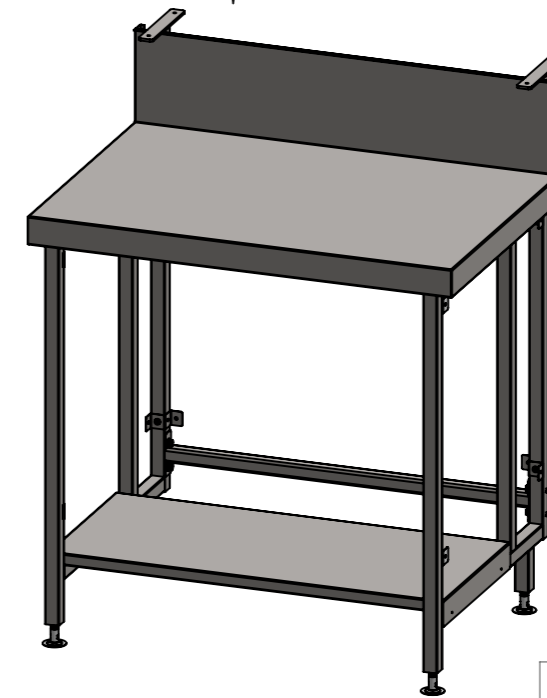
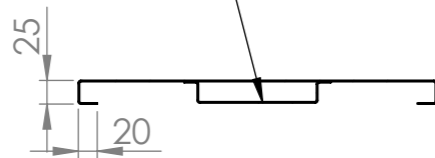

SECTION A-A

SBM-US-6-0900



Simply Bar Solutions

COPYRIGHT © 2020

This drawing is the property of CI GROUP PTY LTD. Tradings as SIMPLY BARS and It may not be copied, reproduced or modified in whole or in part without prior written permission of CI GROUP PTY LTD. SIMPLY BARS reserves the right to change specification and design without notice.

SBM-US-6-0900
BAR MODULE UNDERSHELF

SIZE: A3

SCALE : 1:8

CONSTRUCTION NOTES :

1. UNDERSHELF MADE FROM 1.2mm STAINLESS STEEL.