

PLAN

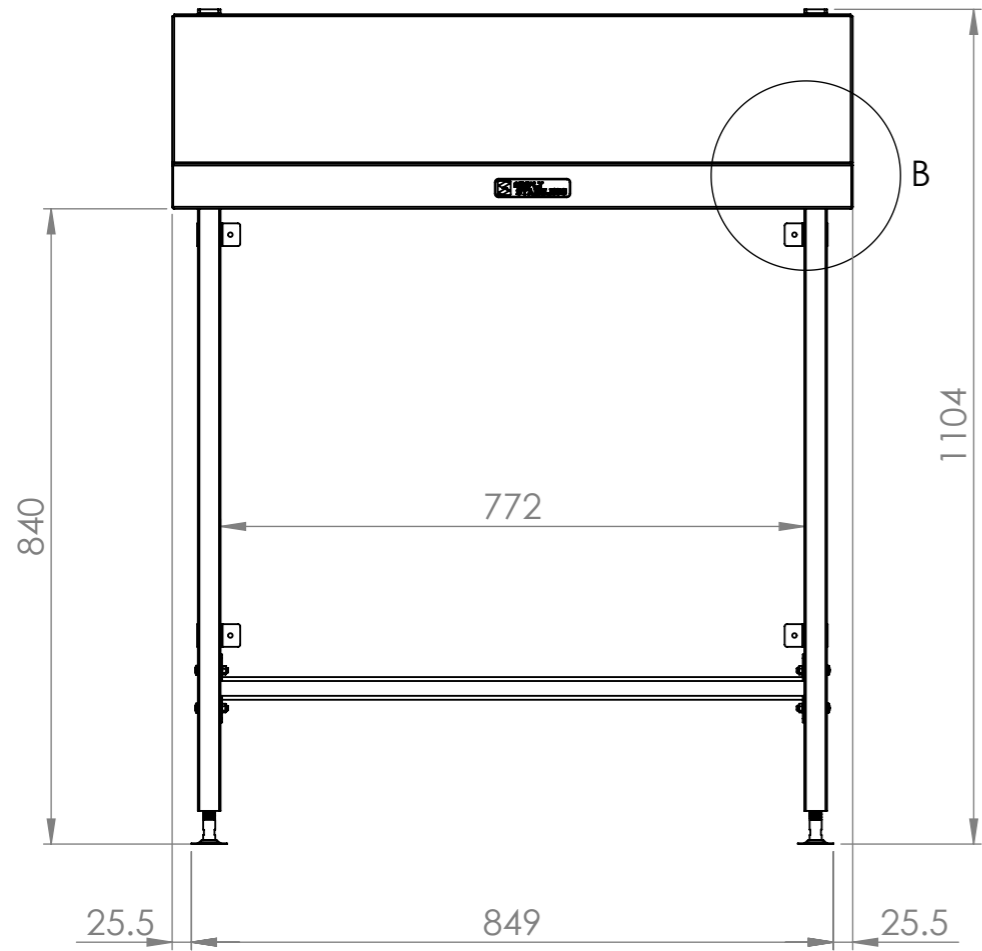

FRONT ELEVATION

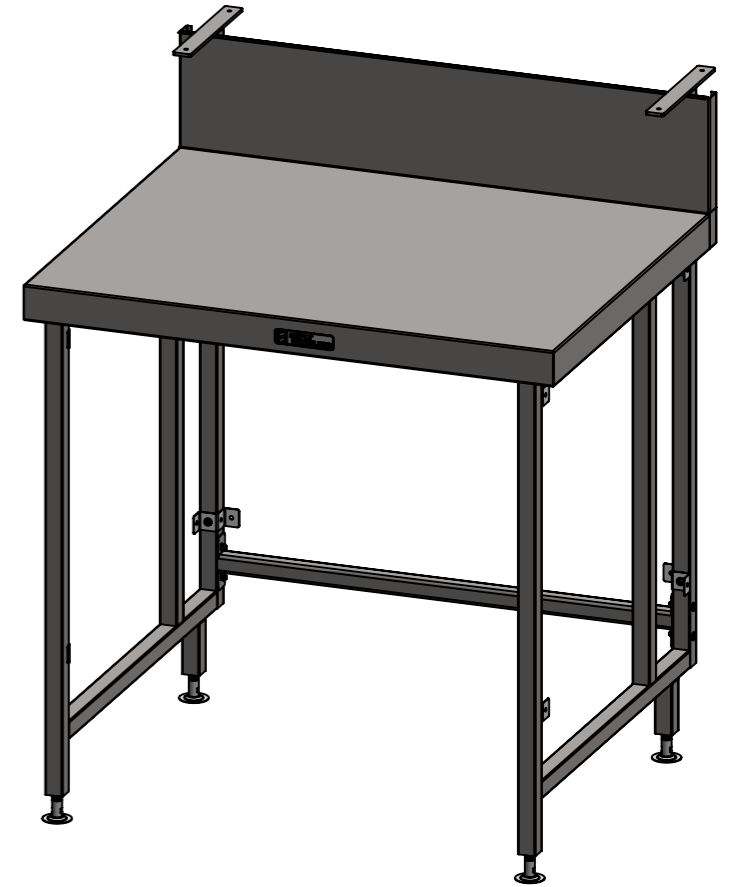
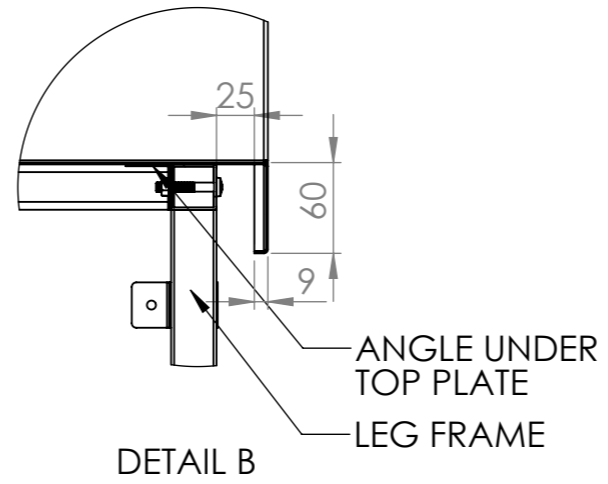
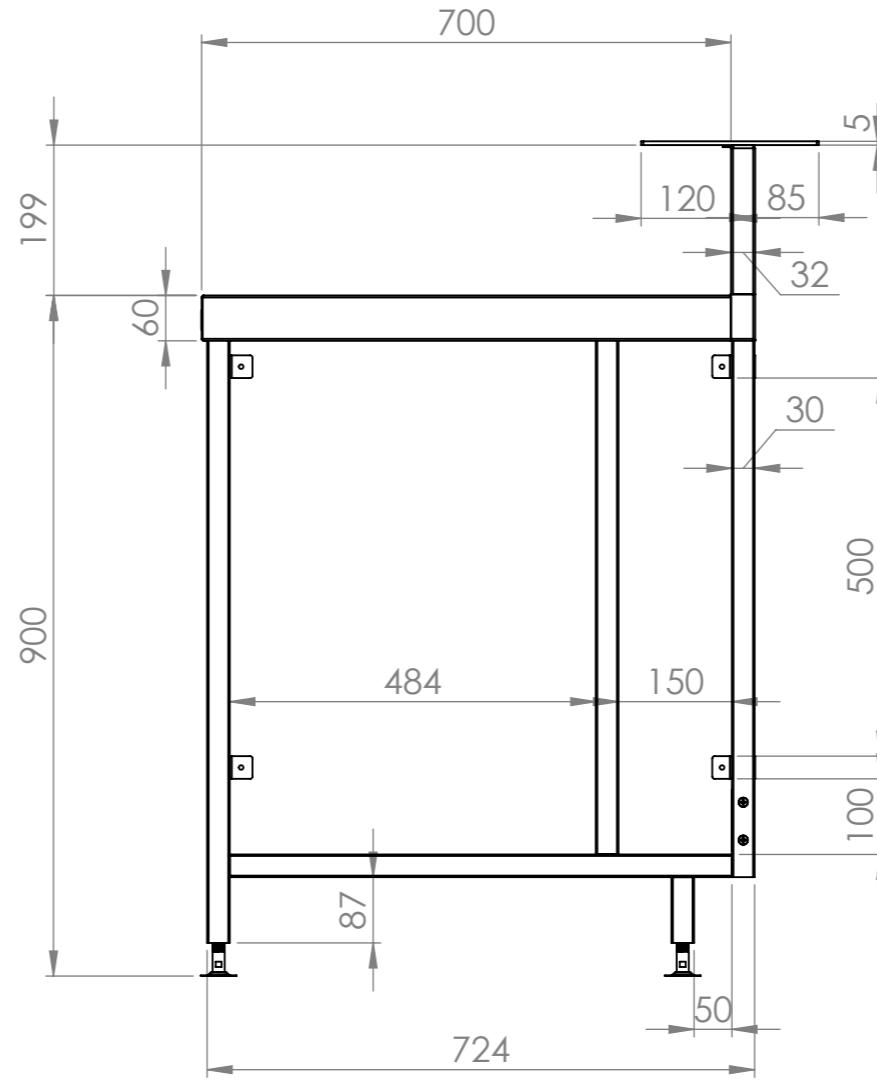

SIDE ELEVATION



Simply Bar Solutions

COPYRIGHT © 2020

This drawing is the property of CI GROUP PTY LTD. Tradings as SIMPLY BARS and It may not be copied, reproduced or modified in whole or in part without prior written permission of CI GROUP PTY LTD. SIMPLY BARS reserves the right to change specification and design without notice.

SBM-7-0900
BAR MODULE 900mm

SIZE: A3

SCALE : 1:12

CONSTRUCTION NOTES :

1. TOPS MADE FROM 304 GRADE, 1.2mm STAINLESS STEEL.
2. LEG FRAME MADE FROM 30mm STAINLESS STEEL SQ TUBE.
3. FEET ARE ADJUSTABLE STAINLESS STEEL DISC SHAPED FEET.

SBM-7-0900