

PLAN

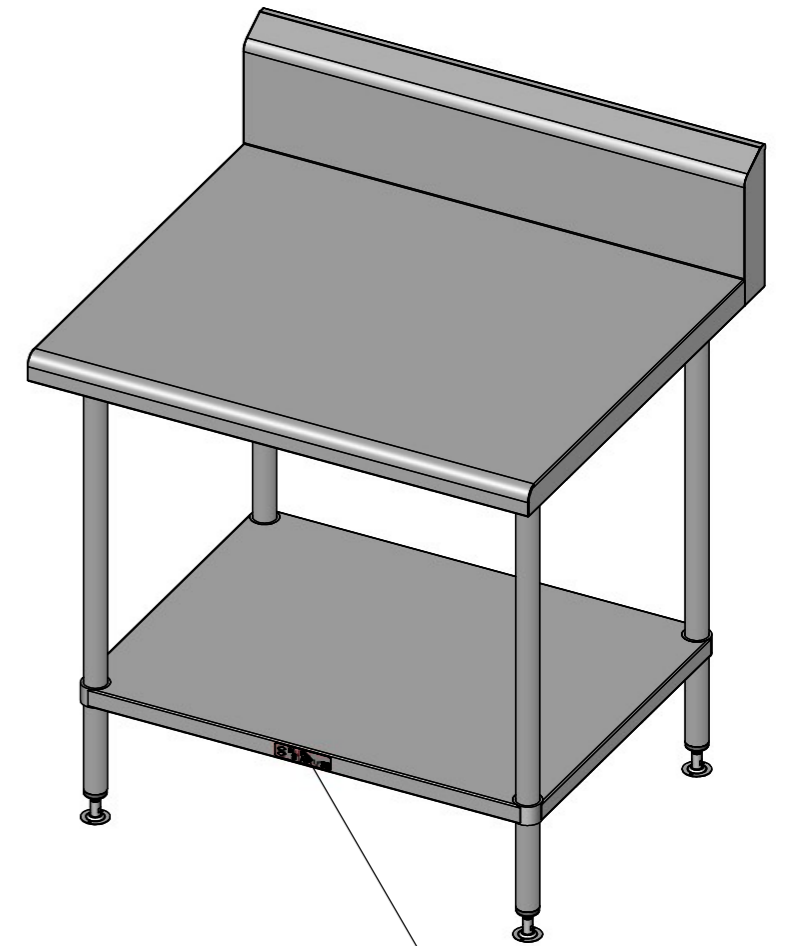

BENCH TOP PROFILE
SCALE 1:8



Simply Stainless Logo
(Using Etching Machine)

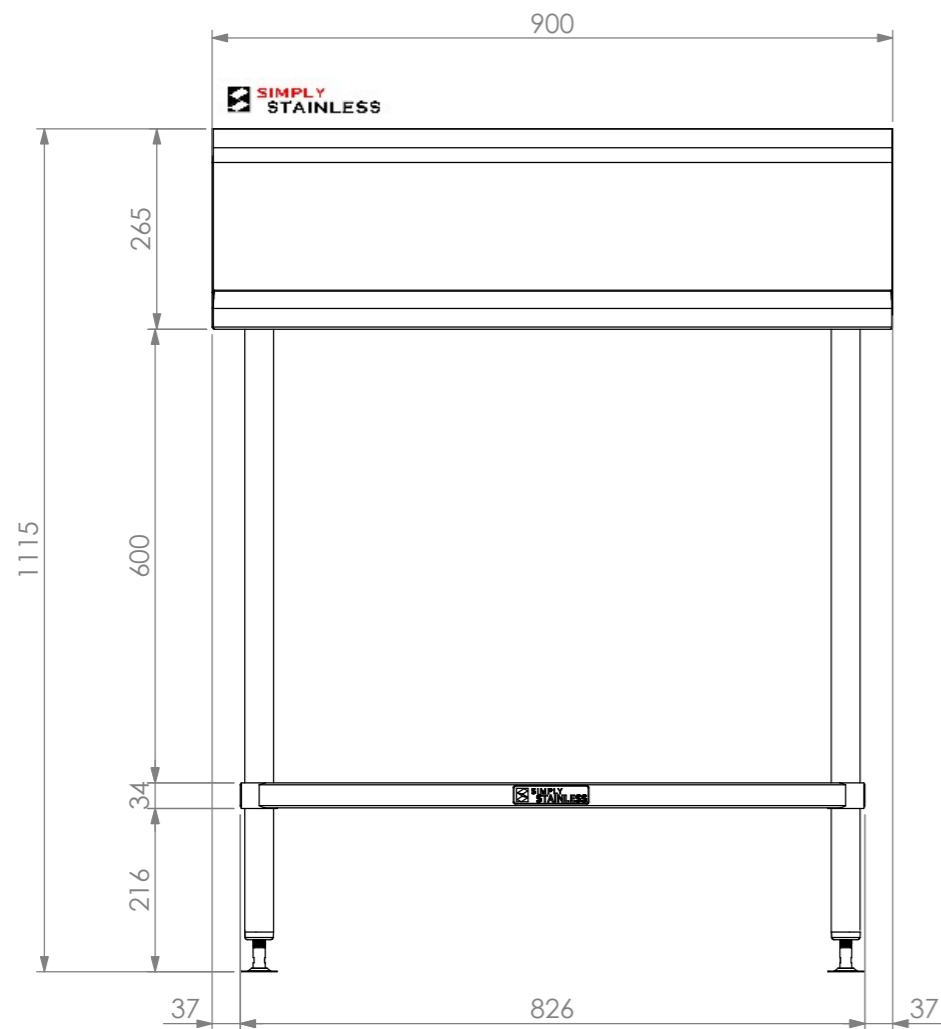

FRONT ELEVATION

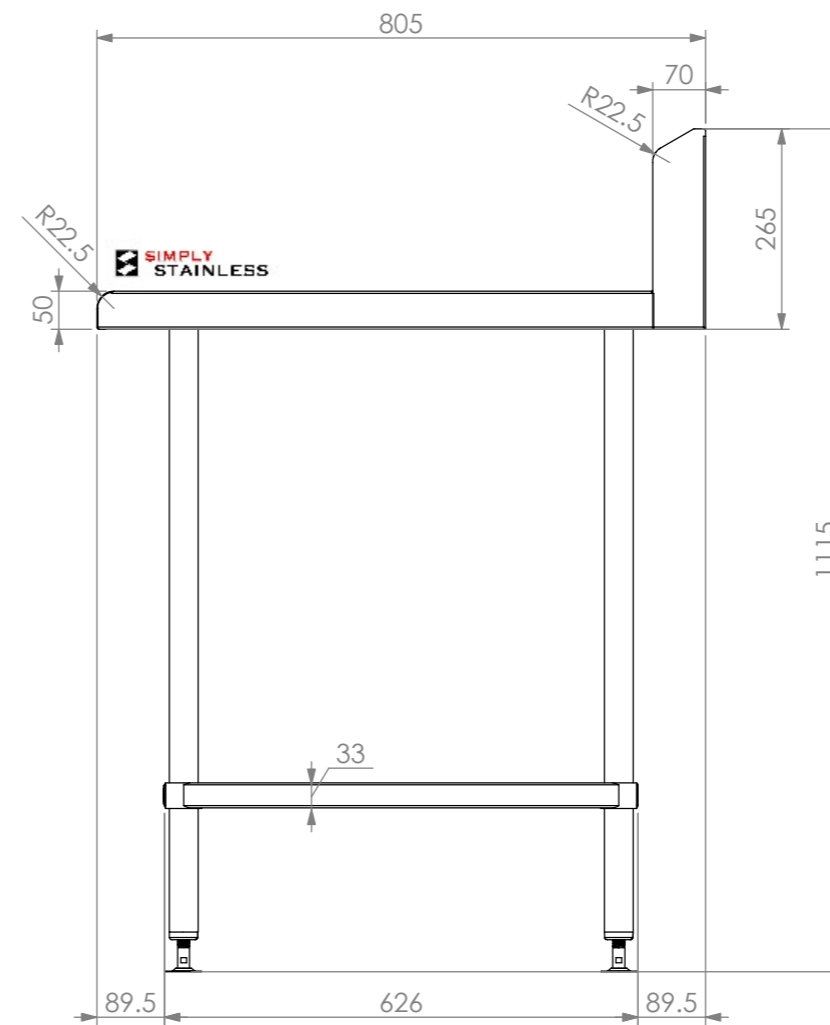

SIDE ELEVATION

31-WD-0900

SIMPLY STAINLESS
www.simplystainless.com

Modular Sinks Tables and Shelving
COPYRIGHT © 2018

This drawing is the property of CI GROUP PTY LTD. Tradings as SIMPLY STAINLESS and It may not be copied, reproduced or modified in whole or in part without prior written permission of CI GROUP PTY LTD. SIMPLY STAINLESS reserves the right to change specification and design without notice.

31-WD-0900
WALDORF INFILL BENCH

SIZE: A3

SCALE : 1:10

CONSTRUCTION NOTES :

1. TOPS MADE FROM 304 GRADE, 1.2mm STAINLESS STEEL.
2. CORE MADE FROM 3.0mm ZINC ANNEAL.
3. FRAME MADE FROM Ø38mm STAINLESS STEEL TUBE
4. UNDERSHELF MADE FROM 1.2mm STAINLESS STEEL.
5. FEET ARE ADJUSTABLE STAINLESS STEEL DISC SHAPED FEET.