

PLAN

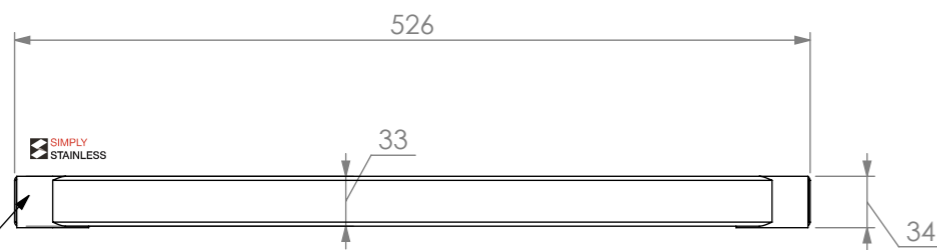

FRONT ELEVATION

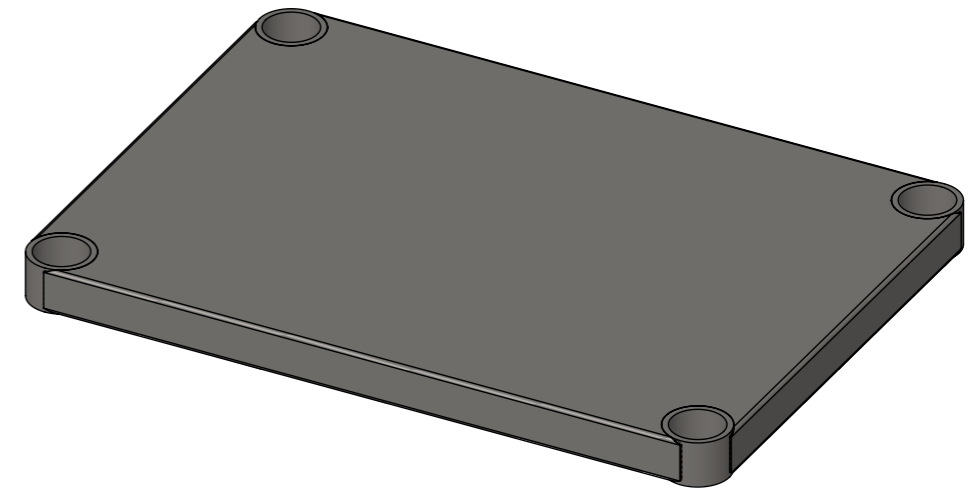
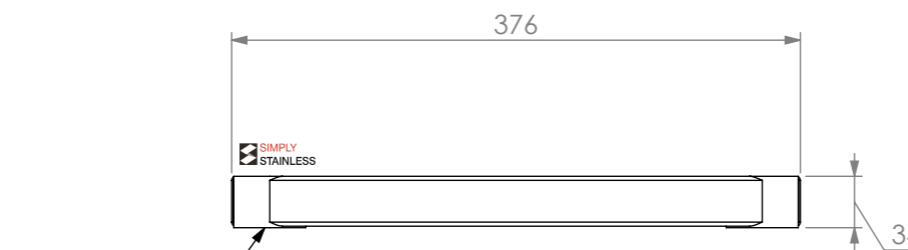

SIDE ELEVATION

21-US-6-0450

SIMPLY STAINLESS
 Modular Sinks, Tables & Shelving
 COPYRIGHT © 2023
 This drawing is the property of CI GROUP PTY LTD. Tradings as SIMPLY STAINLESS and it may not be copied, reproduced or modified in whole or in part without prior written permission of CI GROUP PTY LTD. SIMPLY STAINLESS reserves the right to change specification and design without notice.

21-US-6-0450
UNDERSHELF

SIZE: A3

SCALE: 1:5

CONSTRUCTION NOTES:

1. TOPS MADE FROM 1.2mm STAINLESS STEEL WITH STAINLESS STEEL SOCKETS AT CORNERS.

