

UNDERSHELF ASSEMBLY DETAILS BENCH NOT INCLUDED
(CAN FIT LEFT OR RIGHT SIDE)

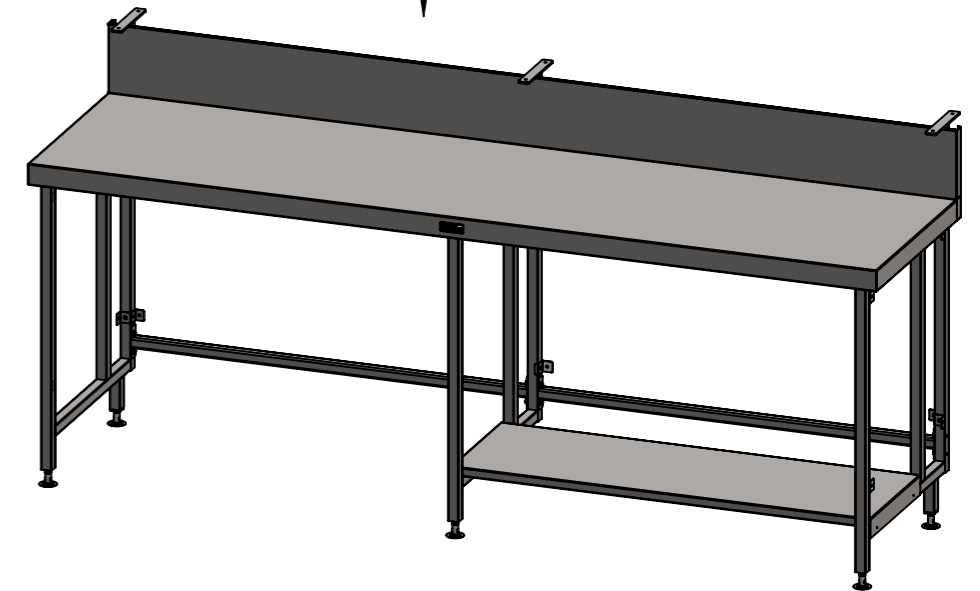

PLAN



FRONT ELEVATION

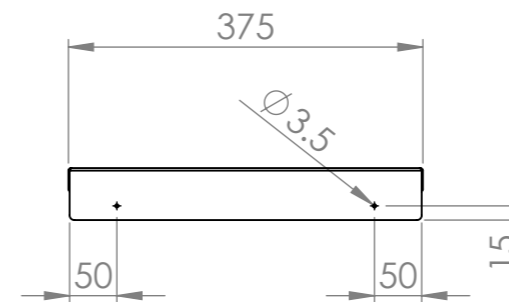

SIDE ELEVATION

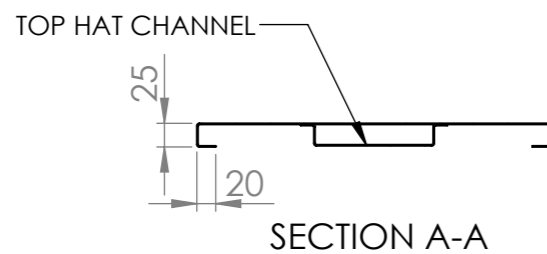

SECTION A-A

SBM-US-6-1186



Modular Bar Solutions

COPYRIGHT © 2022

This drawing is the property of CI GROUP PTY LTD. Tradings as SIMPLY BARS and It may not be copied, reproduced or modified in whole or in part without prior written permission of CI GROUP PTY LTD. SIMPLY BARS reserves the right to change specification and design without notice.

**SBM-US-6-1186(2400 HALF SHELF)
BAR MODULE,UNDERSHELF**

SIZE: A3

SCALE : 1:8

CONSTRUCTION NOTES :

1. UNDERSHELF MADE FROM 1.2mm STAINLESS STEEL.