

PLAN

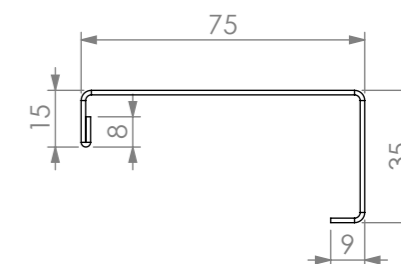

SECTION A-A

SOCKET 33mm x 35mm
 REINFORCING CHANNEL I
 TO PUT SOCKET
 REINFORCING CHANNEL II

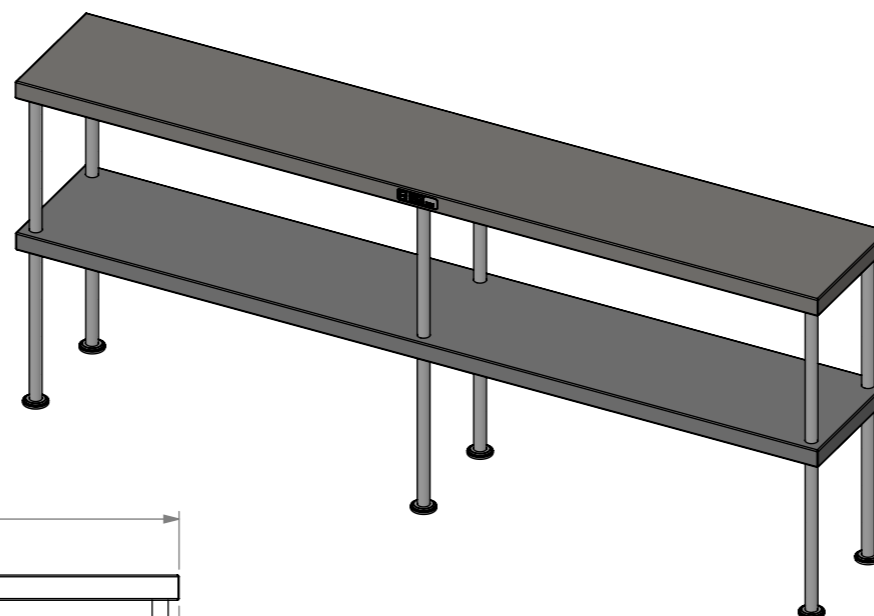

REINFORCING CHANNEL II
 DETAIL



REINFORCING CHANNEL I
 DETAIL

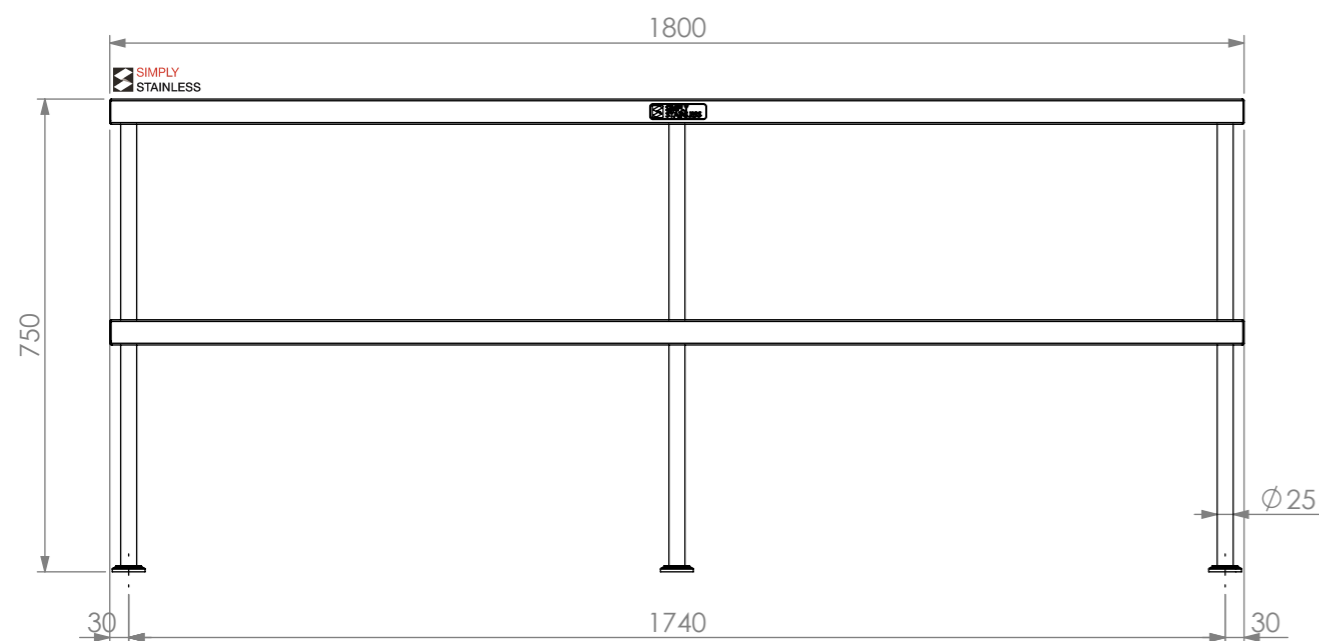

FRONT ELEVATION

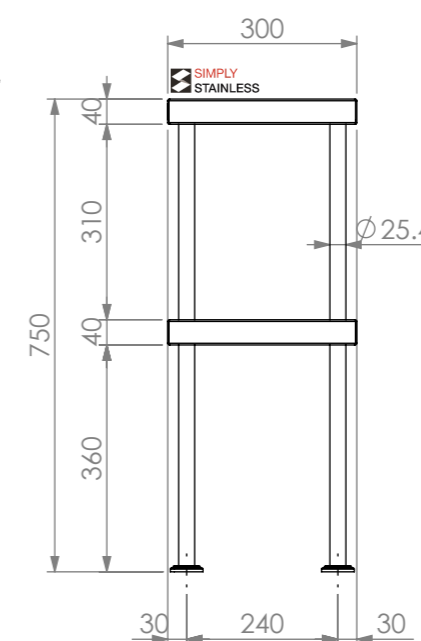

SIDE ELEVATION

SIMPLY STAINLESS
 Modular Sinks, Tables & Shelving
 COPYRIGHT © 2022
 This drawing is the property of CI GROUP PTY LTD. Tradings as SIMPLY STAINLESS and it may not be copied, reproduced or modified in whole or in part without prior written permission of CI GROUP PTY LTD. SIMPLY STAINLESS reserves the right to change specification and design without notice.

**13-1800
 DOUBLE OVERSHELF**

SIZE: A3

SCALE: 1:12

CONSTRUCTION NOTES :

1. TOPS AND SIDE MADE FROM 1.2mm STAINLESS STEEL.
2. REINFORCING CHANNELS MADE FROM 1.2mm STAINLESS STEEL.
3. FRAME MADE FROM Ø25mm STAINLESS STEEL TUBE.
4. FEET ARE ADJUSTABLE STAINLESS STEEL DISC SHAPED FEET.

13-1800