

PLAN

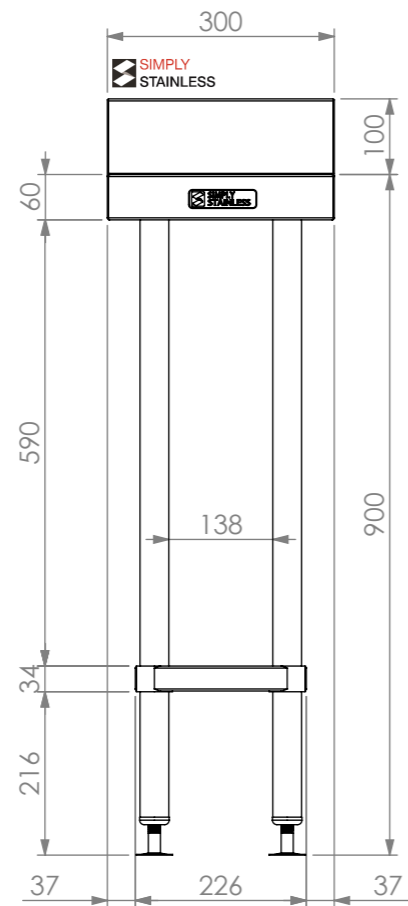

FRONT ELEVATION

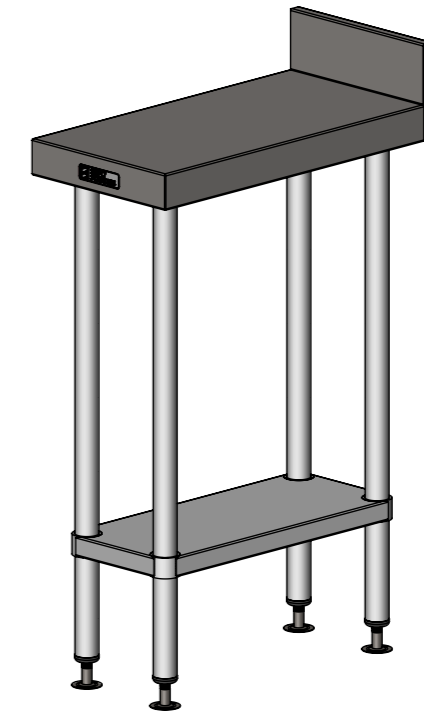
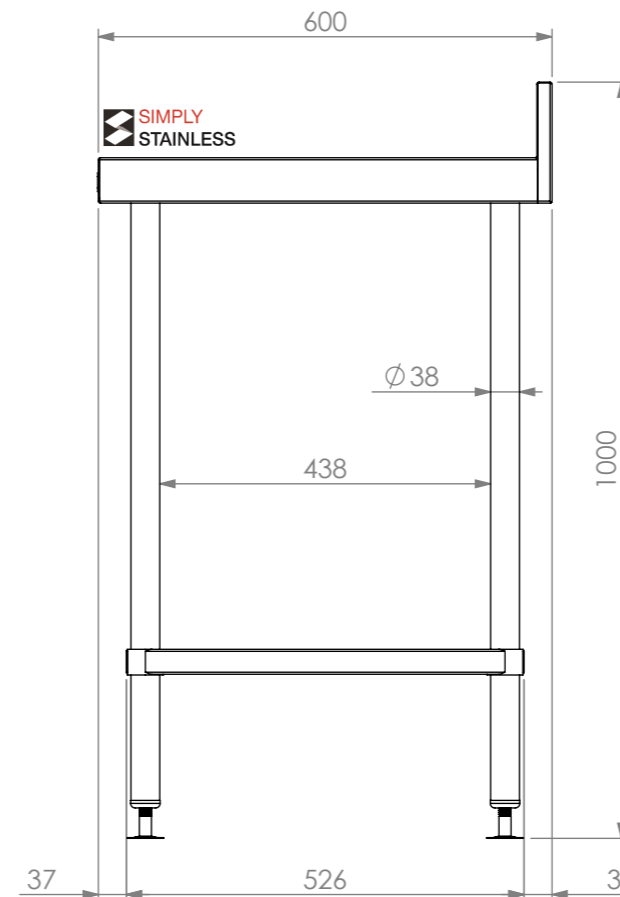

SIDE ELEVATION

**SIMPLY STAINLESS**  
 Modular Sinks, Tables & Shelving  
 COPYRIGHT © 2022

This drawing is the property of CI GROUP PTY LTD. Tradings as SIMPLY STAINLESS and it may not be copied, reproduced or modified in whole or in part without prior written permission of CI GROUP PTY LTD. SIMPLY STAINLESS reserves the right to change specification and design without notice.

**02-6-0300**  
**WORKBENCH W/SPLASHBACK**

SIZE: A3 SCALE : 1:10

**CONSTRUCTION NOTES :**

1. TOPS MADE FROM 304 GRADE, 1.2mm STAINLESS STEEL.
2. CORE MADE FROM 3.0mm ZINC ANNEAL.
3. FRAME MADE FROM Ø38mm STAINLESS STEEL TUBE
4. UNDERSHELF MADE FROM 1.2mm STAINLESS STEEL WITH STAINLESS STEEL SUPPORTS.
5. FEET ARE ADJUSTABLE STAINLESS STEEL DISC SHAPED FEET.

**02-6-0300**