

PLAN

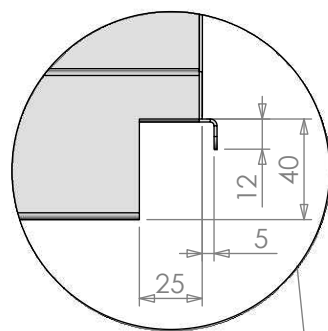

NOTCH DETAIL

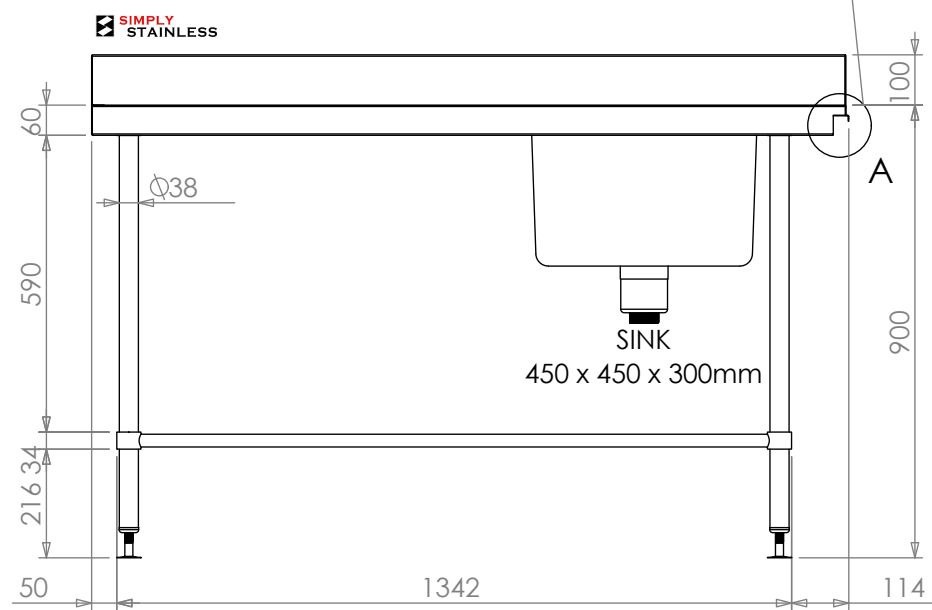

FRONT ELEVATION

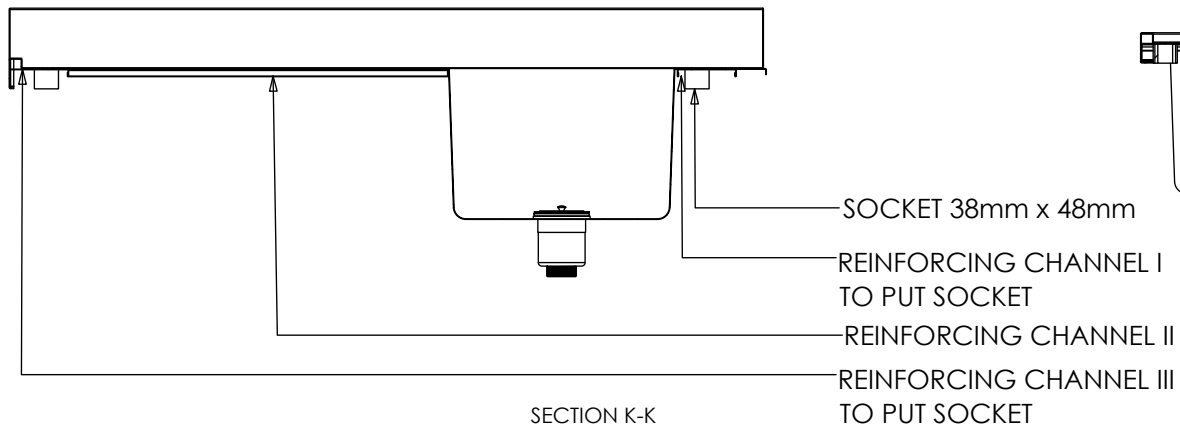

SECTION K-K

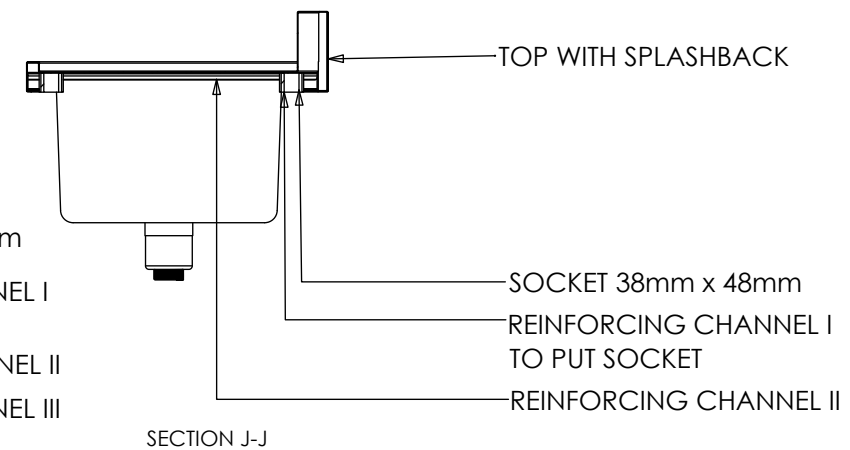

SECTION J-J

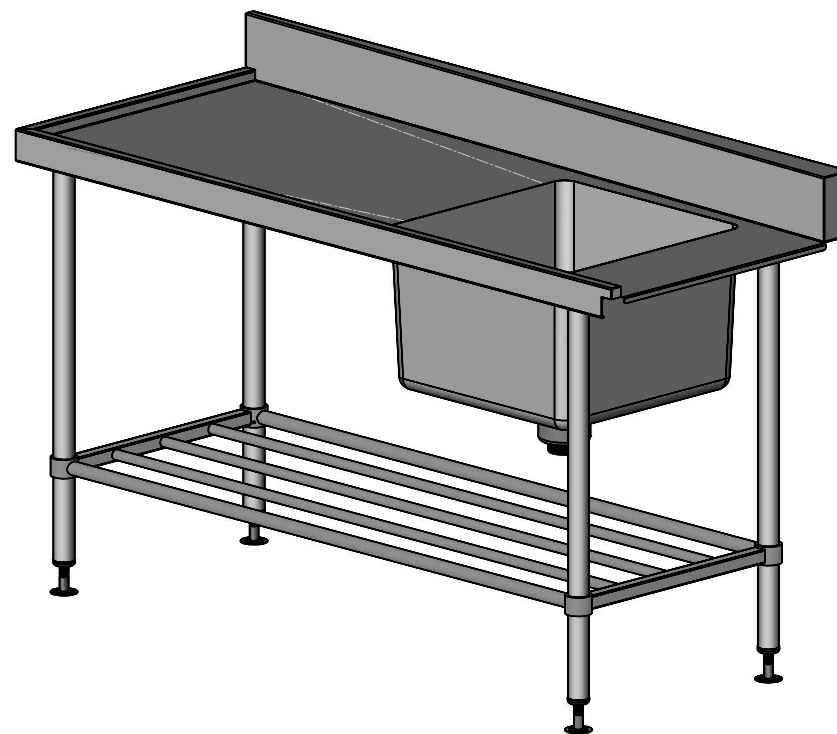

08-6-1500L

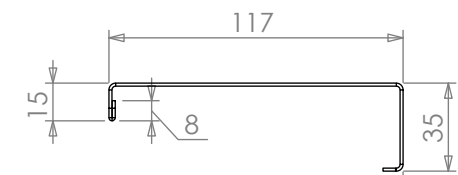

REINFORCING CHANNEL I
DETAIL

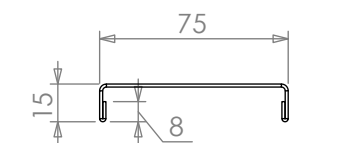

REINFORCING CHANNEL II
DETAIL

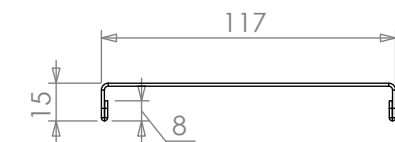

REINFORCING CHANNEL III
DETAIL

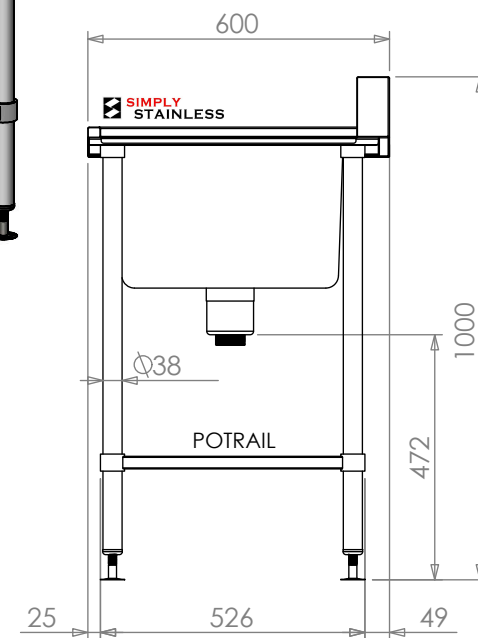

SIDE ELEVATION

SIMPLY STAINLESS
 www.simplystainless.com
 Modular Sinks Tables and Shelving
 COPYRIGHT © 2020
 This drawing is the property of CI GROUP PTY LTD. Tradings as SIMPLY STAINLESS and It may not be copied, reproduced or modified in whole or in part without prior written permission of CI GROUP PTY LTD. SIMPLY STAINLESS reserves the right to change specification and design without notice.

08-6-1500L
DISHWASH INLET BENCH
 SCALE : 1:20

CONSTRUCTION NOTES :

1. TOPS MADE FROM 304 GRADE, 1.2mm STAINLESS STEEL.
2. REINFORCING CHANNEL I & II MADE FROM 1.2mm STAINLESS STEEL.
3. SINKS MADE FROM 1.2mm STAINLESS STEEL.
4. FRAME MADE FROM Ø38mm STAINLESS STEEL TUBE.
5. POTRAIL MADE FROM STAINLESS STEEL ROUND TUBE & SQUARE TUBE.
6. FEET ARE ADJUSTABLE STAINLESS STEEL DISC SHAPED FEET.
7. WATERCORP & WATERMARK APPROVED SINK WASTE INCLUDED.