

PLAN

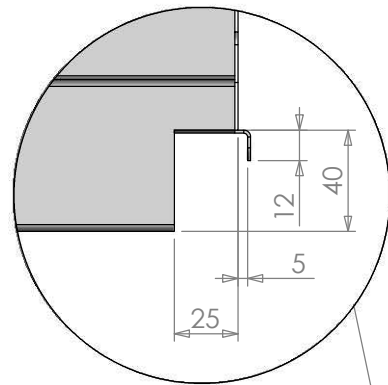

NOTCH DETAIL

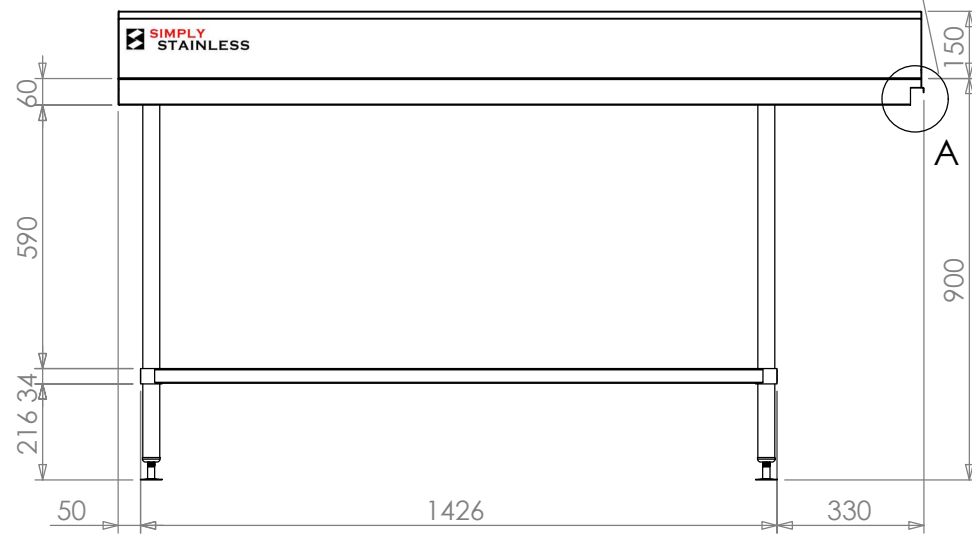

FRONT ELEVATION

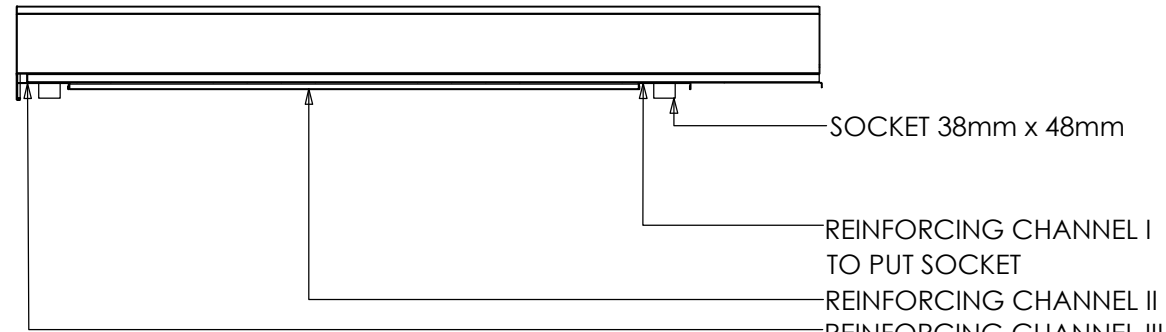

SECTION K-K

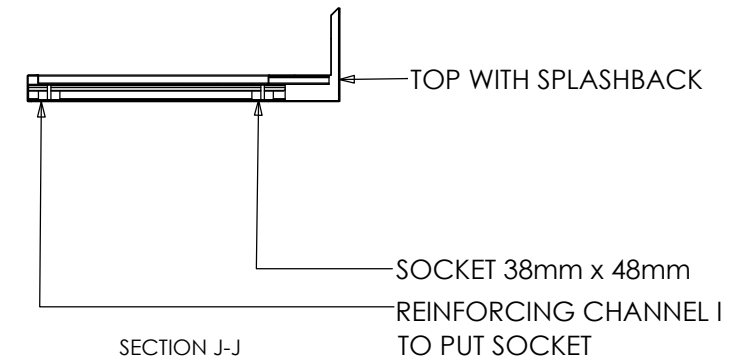

SECTION J-J

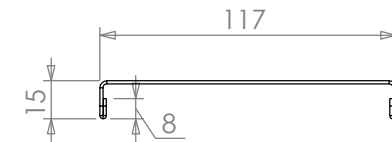

REINFORCING CHANNEL I  
DETAIL

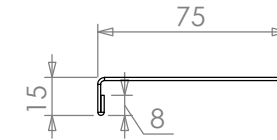

REINFORCING CHANNEL II  
DETAIL

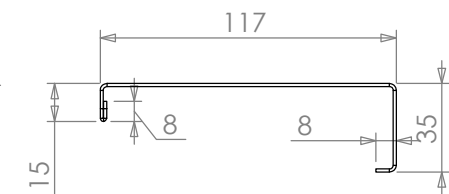

REINFORCING CHANNEL III  
DETAIL

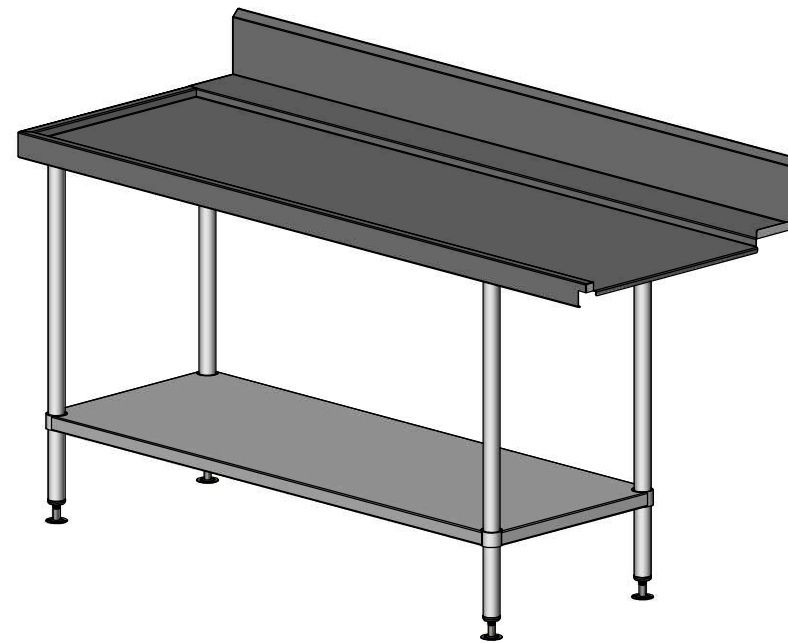

07-7-1800L

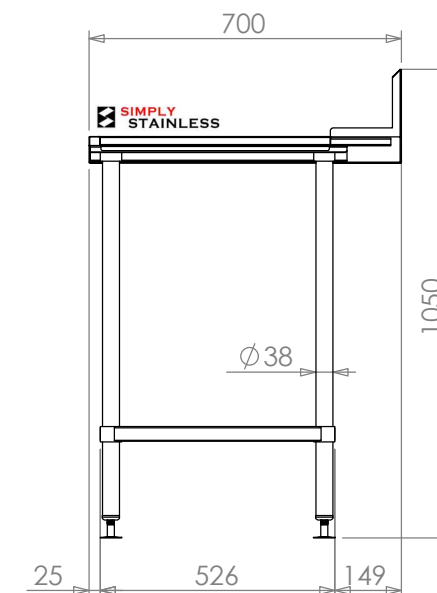

SIDE ELEVATION



www.simplystainless.com  
Modular Sinks Tables and Shelving  
COPYRIGHT © 2020

This drawing is the property of CI GROUP PTY LTD. Tradings as SIMPLY STAINLESS and It may not be copied, reproduced or modified in whole or in part without prior written permission of CI GROUP PTY LTD. SIMPLY STAINLESS reserves the right to change specification and design without notice.

**07-7-1800L**  
**DISHWASH OUTLET BENCH**

SCALE : 1:20

**CONSTRUCTION NOTES :**

1. TOPS MADE FROM 304 GRADE, 1.2mm STAINLESS STEEL.
2. REINFORCING CHANNELS MADE FROM 1.2mm STAINLESS STEEL.
3. FRAME MADE FROM Ø38mm STAINLESS STEEL TUBE
4. UNDERSHELF MADE FROM 1.2mm STAINLESS STEEL WITH STAINLESS STEEL SUPPORTS.
5. FEET ARE ADJUSTABLE STAINLESS STEEL DISC SHAPED FEET.