

PLAN

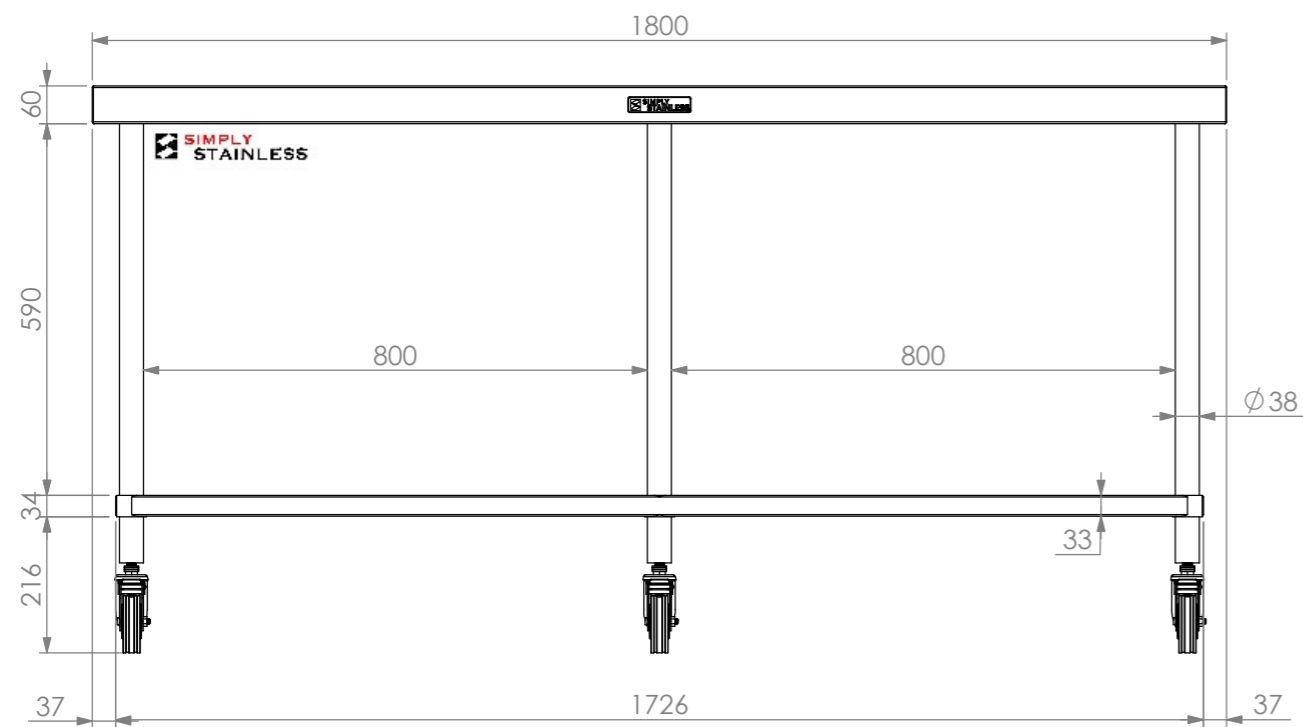

FRONT ELEVATION

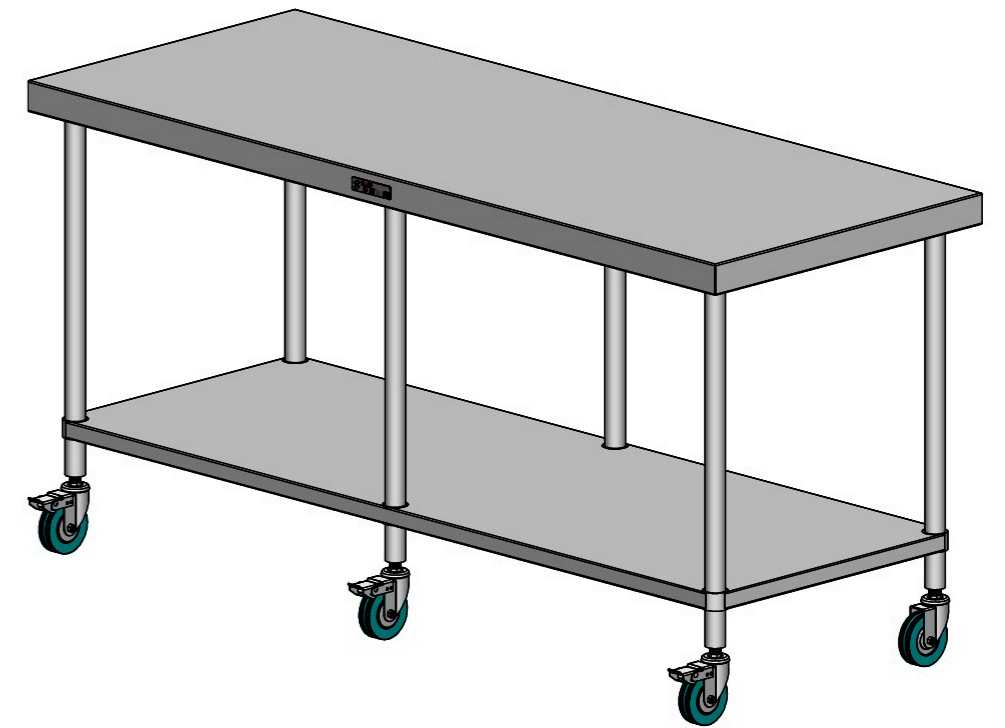
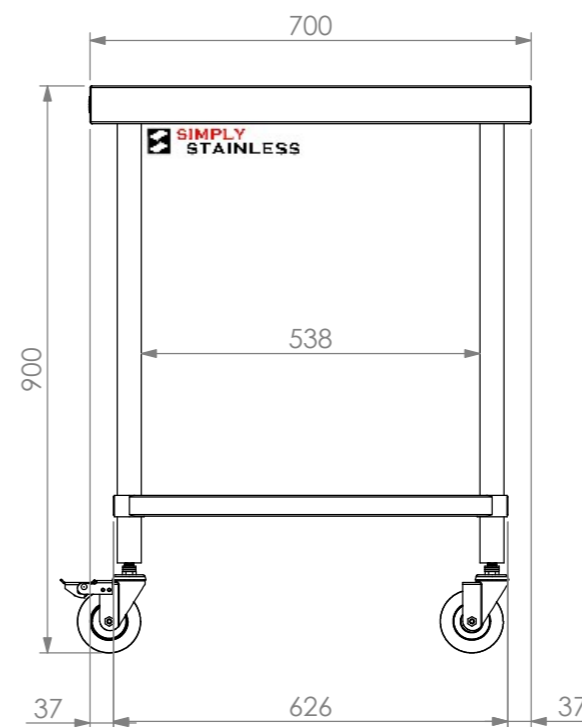

SIDE ELEVATION

SIMPLY STAINLESS
 www.simplystainless.com
 Modular Sinks Tables and Shelving
 COPYRIGHT © 2018
 This drawing is the property of CI GROUP PTY LTD. Tradings as SIMPLY STAINLESS and It may not be copied, reproduced or modified in whole or in part without prior written permission of CI GROUP PTY LTD. SIMPLY STAINLESS reserves the right to change specification and design without notice.

03-7-1800
MOBILE WORKBENCH

SIZE: A3

SCALE : 1:12

CONSTRUCTION NOTES :

1. TOPS MADE FROM 304 GRADE 1.2mm STAINLESS STEEL.
2. CORE MADE FROM 3.0mm ZINC ANNEAL.
3. FRAME MADE FROM Ø38mm STAINLESS STEEL TUBE
4. UNDERSHELF MADE FROM 1.2mm STAINLESS STEEL WITH STAINLESS STEEL SUPPORTS.
5. FEET ARE Ø100mm SWIVEL CASTORS, 3x LOCKING & 3x NON-LOCKING.

03-7-1800